

SCHOTTKY BARRIER DIODE

Features

- Low turn-on voltage
- High breakdown voltage
- Guarding for overvoltage protection
- AEC-Q101 qualified (Automotive grade with suffix "Q.")
- Exsemi technology

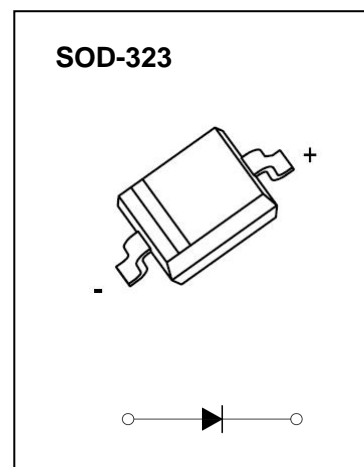

Maximum Ratings and Electrical Characteristics

Ratings at 25°C ambient temperature unless otherwise specified.

Parameter	Symbols	BAT46WS	Units
Maximum Repetitive Peak Reverse Voltage	V_{RRM}	100	V
Working Peak Reverse Voltage	V_{RWM}	100	V
Continuous Forward Current	I_F	150	mA
Repetitive Peak Forward Current ^{Note1} at $t_p < 1.0s$, Duty Cycle $< 50\%$	I_{FRM}	350	mA
Peak Forward Surge Current 8.3 ms Single Half Sine Wave Superimposed on Rated Load	I_{FSM}	0.75	A
Maximum Instantaneous Forward Voltage ^{Note2} at $I_F=10$ mA at $I_F=250$ mA	V_F	0.45 1.0	V
Reverse Breakdown Voltage ^{Note2} at $I_R=100$ uA	$V_{(BR)}$	100	V
Maximum DC Reverse Current at Rated DC Blocking Voltage at $V_R=1.5$ V at $V_R=10$ V at $V_R=50$ V at $V_R=75$ V	I_R	0.3 0.5 1 2	μA
Diodes Capacitance at $V_R=0, f=1MHz$ at $V_R=1V, f=1MHz$	C_T	20 12	pF
Maximum Power Dissipation	P_D	200	mW
Typical Thermal Resistance	$R_{\theta JA}$	500	°C/W
Junction Temperature	T_J	150	°C
Storage Temperature Range	T_{STG}	-55 to +150	°C

Note:

1. Part mounted on FR-4 board with recommended pad layout.
2. Short duration pulse test used to minimize self-heating effect.

Typical Characteristic Curves

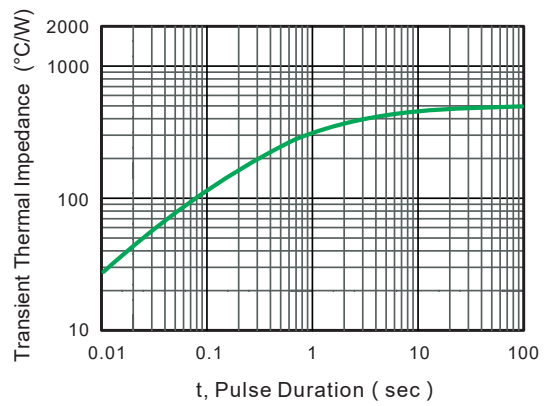
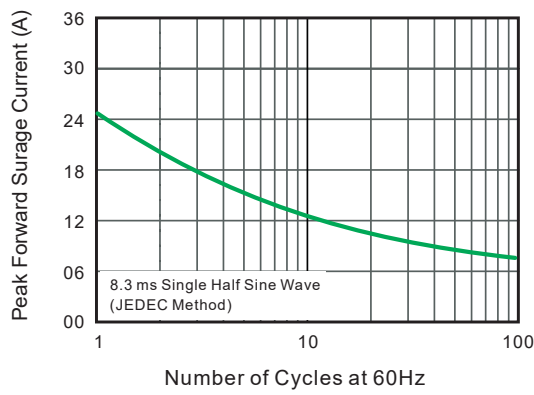
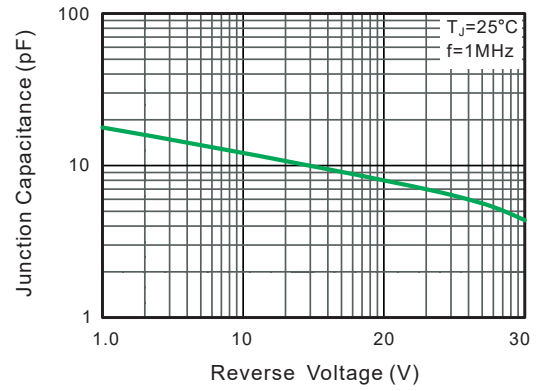
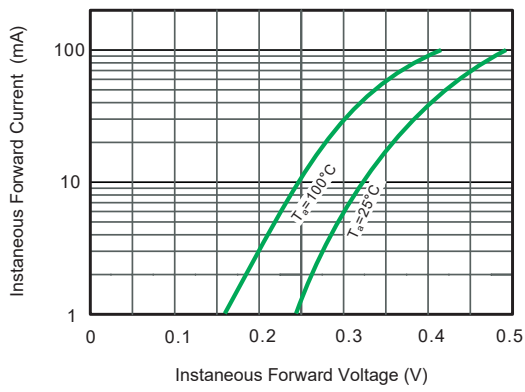
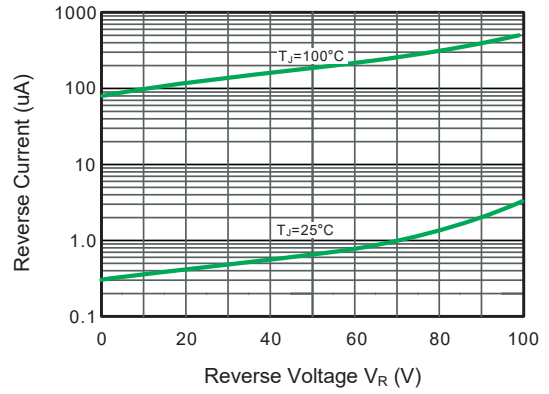
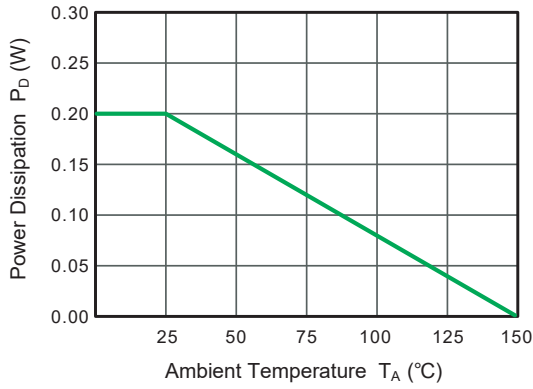

SOD-323 Package Outline Dimensions

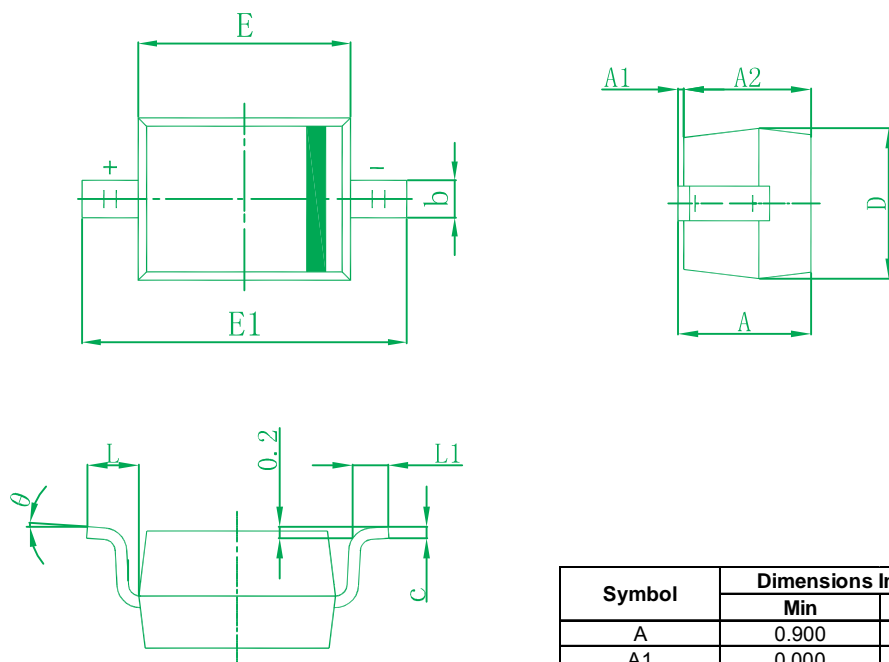

Symbol	Dimensions In Millimeters		Dimensions In Inches	
	Min	Max	Min	Max
A	0.900	1.150	0.035	0.045
A1	0.000	0.100	0.000	0.004
A2	0.900	1.150	0.035	0.045
b	0.250	0.400	0.010	0.015
c	0.080	0.150	0.003	0.006
D	1.150	1.400	0.045	0.055
E	1.600	1.800	0.063	0.071
E1	2.400	2.800	0.094	0.110
L	0.475 REF		0.019REF	
L1	0.250	0.400	0.010	0.016
θ	0°	8°	0°	8°

SOD-323 Suggested Pad Layout

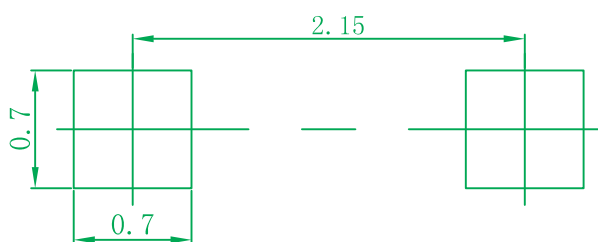
**Note:**

1. Controlling dimension: in millimeters.
2. General tolerance: ± 0.05 mm.
3. The pad layout is for reference purposes only.

Ordering information

Device	Package	Shipping
BAT46WS	SOD-323	3000/Tape&Reel(7inches)