

SCHOTTKY BARRIER DIODE

FEATURES

For use in low voltage, high frequency inverters
 Free wheeling, and polarity protection applications.
 AEC-Q101 qualified (Automotive grade with suffix "Q").
 Exsemi technology

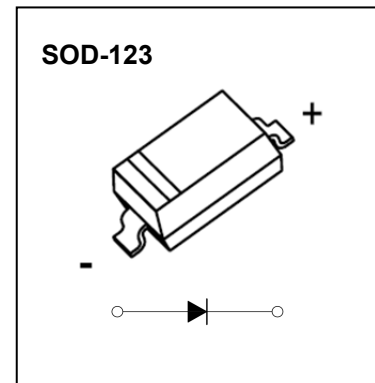

Maximum Ratings and Electrical Characteristics, Single Diode @Ta=25°C

Parameter	Symbol	1N5817W	1N5818W	1N5819W	Unit
Non-Repetitive Peak Reverse Voltage	V_{RM}	20	30	40	V
Peak Repetitive Peak Reverse Voltage Working Peak Reverse Voltage DC Blocking Voltage	V_{RRM} V_{RWM} V_R	20	30	40	V
RMS Reverse Voltage	$V_{R(RMS)}$	14	21	28	V
Average Rectified Output Current	I_O	1			A
Non-repetitive Peak Forward Surge Current @t=8.3ms	I_{FSM}	9			A
Repetitive Peak Forward Current	I_{FRM}	1.5			A
Power Dissipation	P_d	500			mW
Thermal Resistance Junction to Ambient	$R_{\theta JA}$	200			°C/W
Junction temperature	T_J	125			°C
Storage Temperature	T_{STG}	-55~+150			°C

ELECTRICAL CHARACTERISTICS (Ta=25°C unless otherwise specified)

Parameter	Symbol	Test conditions	Min	Max	Unit
Reverse breakdown voltage	$V_{(BR)}$	$I_R=1mA$ 5817W 5818W 5819W	20 30 40		V
Reverse voltage leakage current	I_R	$V_R=20V$ 5817W $V_R=30V$ 5818W $V_R=40V$ 5819W		1	mA
Forward voltage	V_F	5817W $I_F=1A$ $I_F=3A$		0.45 0.75	V
		5818W $I_F=1A$ $I_F=3A$		0.55 0.875	V
		5819W $I_F=1A$ $I_F=3A$		0.6 0.9	V
Diode capacitance	C_D	$V_R=4V, f=1MHz$		120	pF

Typical Characteristics

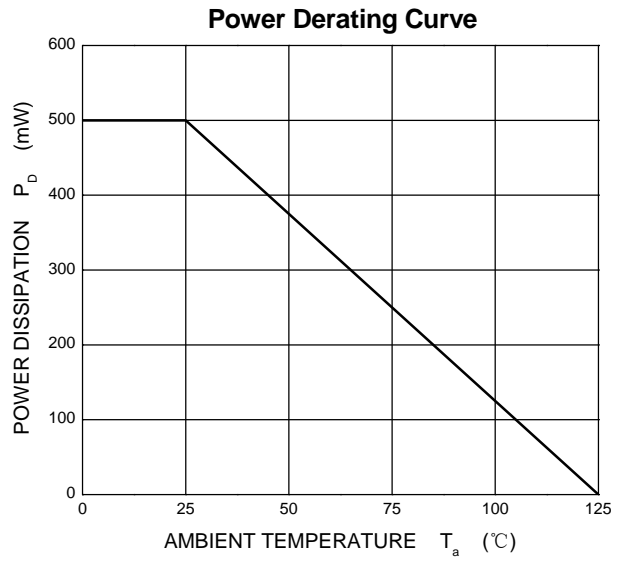
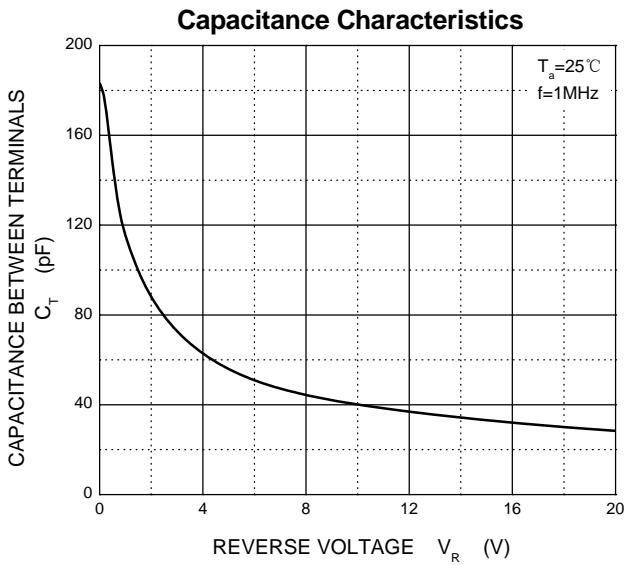
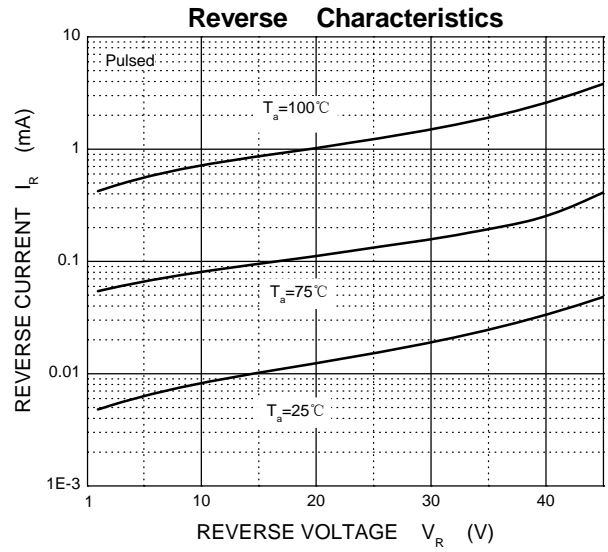
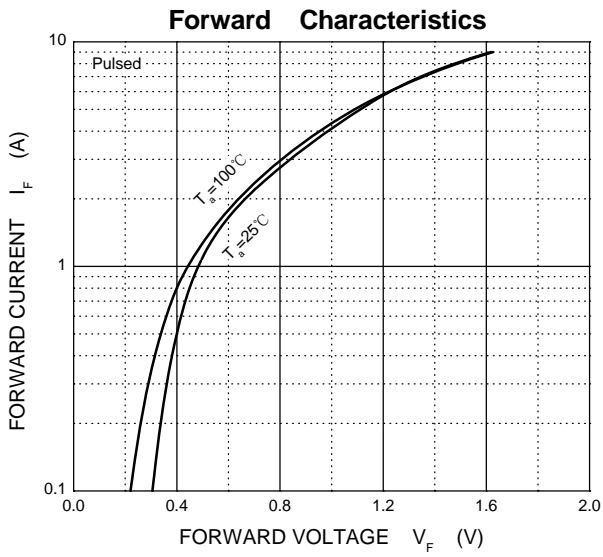

SOD-123 Package Outline Dimensions

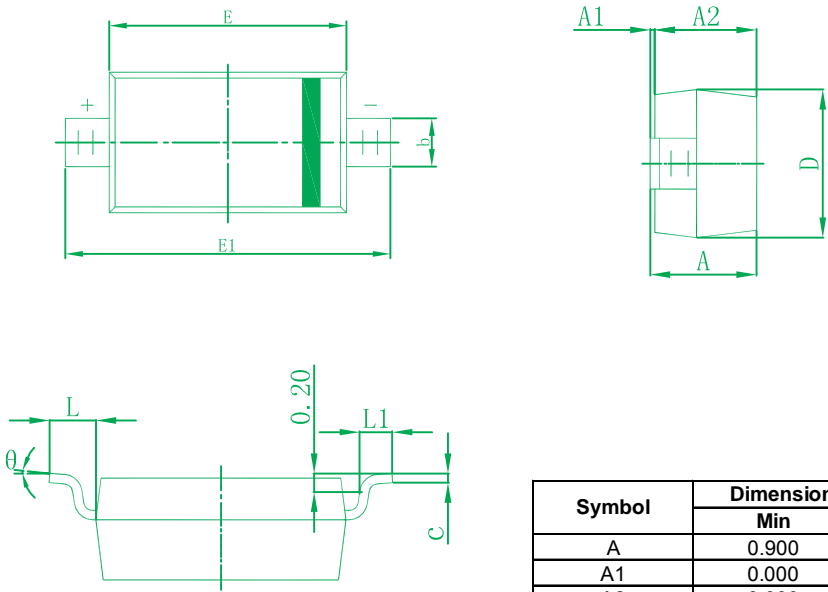

Symbol	Dimensions In Millimeters		Dimensions In Inches	
	Min	Max	Min	Max
A	0.900	1.250	0.035	0.049
A1	0.000	0.100	0.000	0.004
A2	0.900	1.150	0.035	0.045
b	0.450	0.650	0.018	0.026
c	0.080	0.150	0.003	0.006
D	1.500	1.700	0.059	0.067
E	2.600	2.800	0.102	0.110
E1	3.550	3.850	0.140	0.152
L	0.500 REF		0.020 REF	
L1	0.250	0.450	0.010	0.018
θ	0°	8°	0°	8°

SOD-123 Suggested Pad Layout

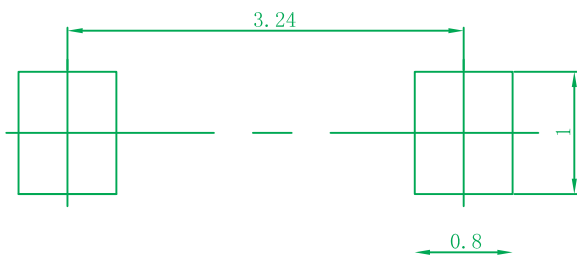

- Note:**
1. Controlling dimension: in millimeters.
 2. General tolerance: $\pm 0.05\text{mm}$.
 3. The pad layout is for reference purposes only.

Ordering information

Device	Package	Shipping
1N58XXW	SOD-123	3000/Tape&Reel(7inches)