

Transient Voltage Suppressors (TVS) Data Sheet

Features

- Available in uni/bi -directional polarity.
- Low forward voltage drop & Low leakage current.
- High surge capability.
- Junction passivation optimized design passivated anisotropic rectifier technology.
- $T_J = 175^{\circ}\text{C}$ capability suitable for high reliability and automotive requirement.
- Meets ISO7637-2 surge specification (varied by test condition).
- Meets MSL level 1, per J-STD-020, LF maximum peak of 245°C
- AEC-Q101 qualified (Automotive grade with suffix "Q").
- Exsemi technology



Applications

SM5S Series TVS diodes can be used in sensitive electronics protection against voltage transients induced by inductive load switching and lighting, especially for automotive load dump protection application.

ABSOLUTE MAXIMUM RATINGS ($T_A=25^{\circ}\text{C}$, RH=45%-75%, unless otherwise noted)

Parameter	Symbol	Value	Unit
Peak pulse power dissipation on 10/1000us waveform	P_{pp}	3600	Watts
Peak pulse power dissipation on 10/10000us waveform		2800	Watts
Peak pulse current with 10/1000us waveform	I_{pp}	See next table	Amps
Power dissipation on infinite heat Sink at $T_C=25^{\circ}\text{C}$	P_D	5.0	Watts
Peak forward surge current, 8.3ms single half sine-wave	I_{FSM}	500	Amps
Operating Junction and Storage Temperature Range	T_J, T_{STG}	-55 to +150	$^{\circ}\text{C}$
Typical thermal resistance, junction to case	$R_{\theta JC}$	1.0	$^{\circ}\text{C}/\text{Watt}$

ELECTRICAL CHARACTERISTICS

Part Number		V_R	$I_R @ V_R$		$V_{BR} @ I_T$		I_T	$V_C @ I_{pp}$	I_{pp}
Uni-polar	Bi-polar	V	$\mu A @ 25^\circ C$	$\mu A @ 175^\circ C$	min(V)	max (V)	mA	V	A
SM5S10A	SM5S10CA	10.0	5	250	11.1	12.3	5	17.0	212.0
SM5S11A	SM5S11CA	11.0	5	150	12.2	13.5	5	18.2	198.0
SM5S12A	SM5S12CA	12.0	5	150	13.3	14.7	5	19.9	181.0
SM5S13A	SM5S13CA	13.0	5	150	14.4	15.9	5	21.5	167.0
SM5S14A	SM5S14CA	14.0	5	150	15.6	17.2	5	23.2	155.0
SM5S15A	SM5S15CA	15.0	5	150	16.7	18.5	5	24.4	148.0
SM5S16A	SM5S16CA	16.0	5	150	17.8	19.7	5	26.0	138.0
SM5S17A	SM5S17CA	17.0	5	150	18.9	20.9	5	27.6	130.0
SM5S18A	SM5S18CA	18.0	5	150	20.0	22.1	5	29.2	123.0
SM5S20A	SM5S20CA	20.0	5	150	22.2	24.5	5	32.4	111.0
SM5S22A	SM5S22CA	22.0	5	150	24.4	26.9	5	35.5	101.0
SM5S24A	SM5S24CA	24.0	5	150	26.7	29.5	5	38.9	93.0
SM5S26A	SM5S26CA	26.0	5	150	28.9	31.9	5	42.1	86.0
SM5S28A	SM5S28CA	28.0	5	150	31.1	34.4	5	45.4	79.0
SM5S30A	SM5S30CA	30.0	5	150	33.3	36.8	5	48.4	74.0
SM5S33A	SM5S33CA	33.0	5	150	36.7	40.6	5	53.3	68.0
SM5S36A	SM5S36CA	36.0	5	150	40.0	44.2	5	58.1	62.0

Note:

① For all types maximum $V_F = 2.0$ V at $I_F = 100$ A measured on 8.3 ms single half sine-wave or equivalent square wave, duty cycle = 4 pulses per minute maximum.

②. Surge waveform: 10/1000 μ s

V_R : Stand-off Voltage -- Maximum voltage that can be applied

V_{BR} : Breakdown Voltage

V_C : Clamping Voltage -- Peak voltage measured across the suppressor at a specified I_{pp}

I_R : Reverse Leakage Current

I_T : Test current

RATINGS AND CHARACTERISTICS CURVES ($T_A=25^{\circ}\text{C}$, unless otherwise noted)

FIG.1: Power Derating Curve

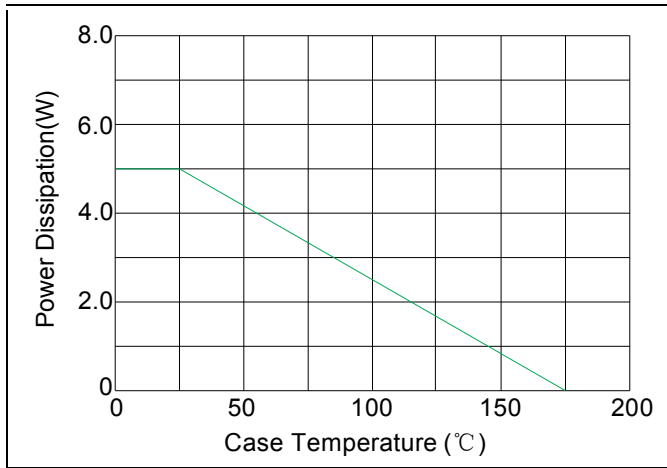

FIG.2: Pulse Waveform

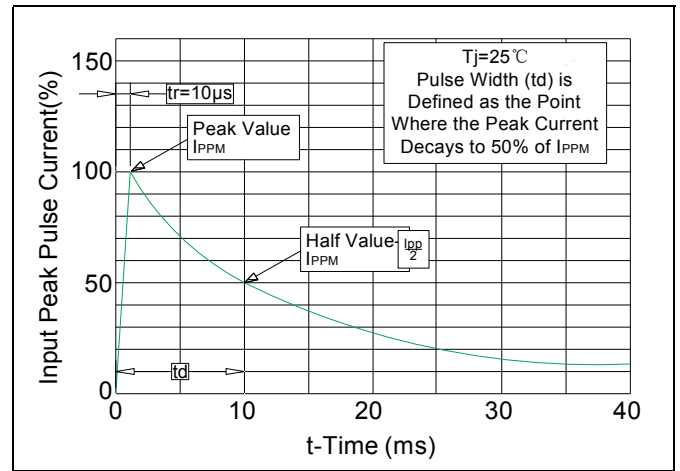

FIG.3: Load Dump Power Characteristics
(10ms Exponential Wavaform)

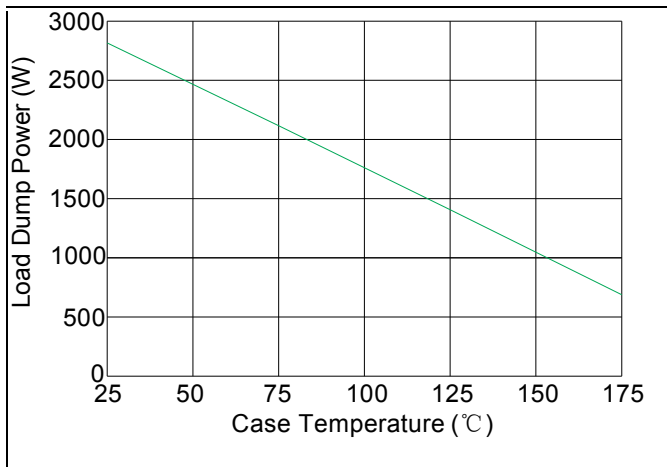

FIG.4: Reverse Power Capability

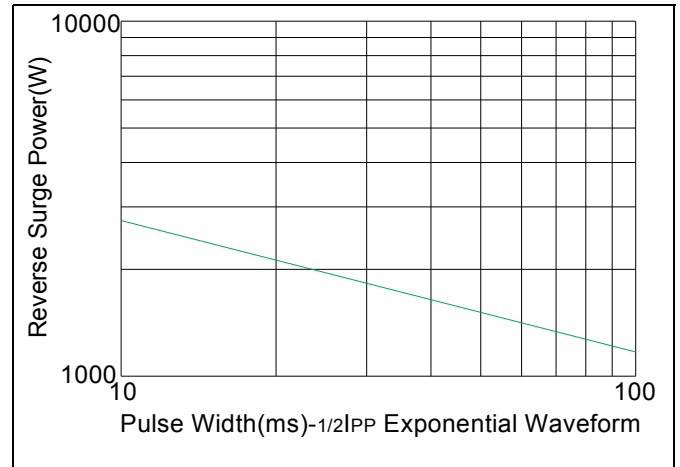
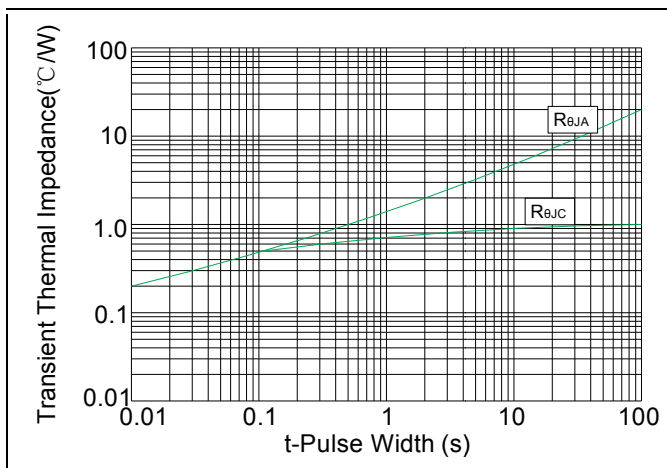

FIG.5: Typical Transient Thermal Impedance



Recommended Soldering Conditions

Soldering Parameters

Reflow Condition		Pb – Free assembly
Pre Heat	- Temperature Min ($T_{s(min)}$)	150°C
	- Temperature Max ($T_{s(max)}$)	200°C
	- Time (min to max) (t_s)	60 – 180 secs
Average ramp up rate (Liquidus Temp) (T_L) to peak		5°C/second max
$T_{s(max)}$ to T_L - Ramp-up Rate		5°C/second max
Reflow	- Temperature (T_L) (Liquidus)	217°C
	- Time (min to max) (T_S)	60 – 150 seconds
Peak Temperature (T_p)		260 ^{+0/-5} °C
Time within 5°C of actual peak Temperature (t_p)		20 – 40 seconds
Ramp-down Rate		5°C/second max
Time 25°C to peak Temperature (T_p)		8 minutes Max.
Do not exceed		260°C

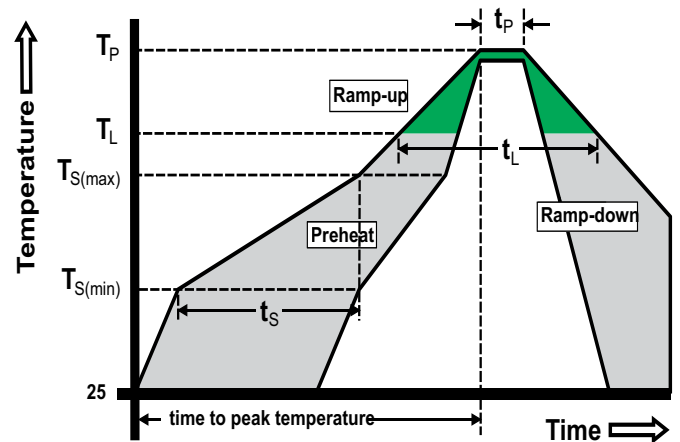

Physical Specifications

Terminal Finish	100% Matte Tin-plated
Body Material	UL Recognized compound meeting flammability rating V-0
Lead Material	Copper Alloy

Environmental Specifications

High Temp. Storage	JESD22-A103
HTRB	JESD22-A108
Temperature Cycling	JESD22-A104
MSL	JEDEC-J-STD-020, LEVEL 1
H3TRB	JESD22-A101
RSH	JESD22-A111

Dimensions

DO-218AB

	Dimension	Inches		Millimeters	
		Min	Max	Min	Max
A	0.374	0.413	9.5	10.5	
B	0.327	0.342	8.3	8.7	
C	0.524	0.539	13.3	13.7	
D	0.592	0.628	15.0	16.0	
E	0.335	0.358	8.5	9.1	
F	0.374	0.398	9.5	10.1	
G	0.098	0.137	2.5	3.5	
H	0.020	0.028	0.5	0.7	
J	0.098	0.137	2.5	3.5	
K	0.075	0.083	1.9	2.1	
L	0.185	0.204	4.7	5.2	
M	0.059	0.098	1.5	2.5	

Part Numbering System

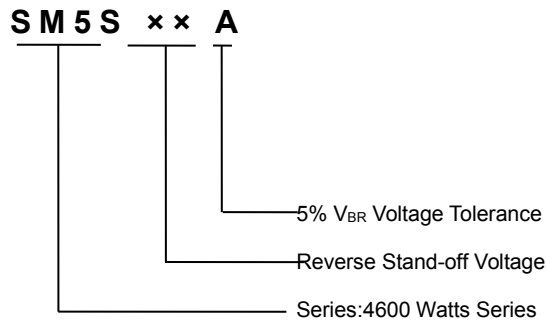

Part Marking System

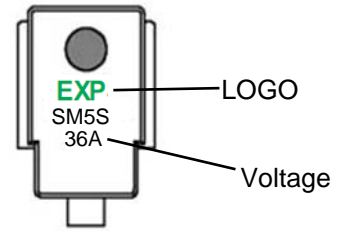

Packaging

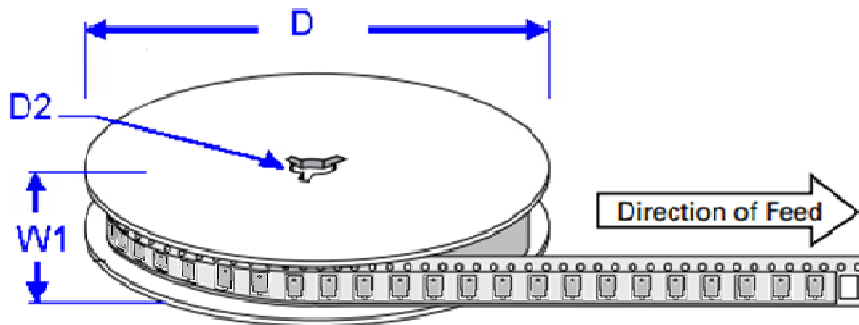

Dimensions	millimeters	inches
D	330 ± 0.2	13.0 ± 0.008
D2	13.2 ± 0.2	0.52 ± 0.008
W1	24 ± 0.2	0.94 ± 0.008

OUTLINE	REEL (PCS)	PER CARTON (PCS)	REEL DIAMETERS (mm)
TAPING	750	3000	330